

03/2022

# Mod: AL4S/FS

Production code: AT68X1511-DM+KAST0001\_

**SEASONER CABINET**

GB

**INSTALLATION, OPERATING AND MAINTENANCE  
INSTRUCTIONS**



## 1. INDEX

|  |    |
|--|----|
| 1. INDEX.....  | 1  |
| 2. ANALYTICAL INDEX.....                               | 2  |
| 3. SAFETY.....   | 3  |
| 4. REGULATIONS AND GENERAL INSTRUCTIONS.....           | 4  |
| 4.1. General information.....                          | 4  |
| 4.2. Warranty.....                                     | 4  |
| 4.3. Description of the Appliance.....                 | 4  |
| 4.4. Features Plate.....                               | 5  |
| 4.5. Replacement of Parts.....                         | 5  |
| 5. USE AND FUNCTIONING.....                            | 6  |
| 5.1. First Switching.....                              | 6  |
| 5.2. Manual Seasoning Cycle.....                       | 6  |
| 5.3. Automatic Seasoning Cycle.....                    | 8  |
| 5.4. Recipe book.....                                  | 11 |
| 5.5. Settings.....                                     | 11 |
| 5.6. Use of the USB port (Optional).....               | 12 |
| 5.7. Recommendations for Use.....                      | 13 |
| 6. CLEANING AND MAINTENANCE.....                       | 13 |
| 6.1. Recommendations for Cleaning and Maintenance..... | 13 |
| 6.2. Routine Maintenance.....                          | 14 |
| 6.3. Extraordinary maintenance.....                    | 14 |
| 7. FAULTS.....   | 14 |
| 7.1. Alarms Display.....                               | 15 |
| 8. INSTALLATION.....                                   | 18 |
| 8.1. Packaging And Unpacking.....                      | 18 |
| 8.2. Installation.....                                 | 18 |
| 8.3. Electric Power Supply Connection.....             | 19 |
| 8.4. Water connection.....                             | 20 |
| 8.5. Inspection.....                                   | 21 |
| 9. TECHNICAL NOTES.....                                | 21 |
| 9.1. Accessory wheels assembly kit.....                | 21 |
| 9.2. Reversibility of the Doors.....                   | 22 |
| 10. DISPOSAL OF THE APPLIANCE.....                     | 23 |
| 11. REFRIGERANT TECHNICAL CARD.....                    | 23 |
| ATTACHMENTS.....                                       | I  |

## 2. ANALYTICAL INDEX

### A

Accessory wheels assembly kit; 21  
 Air Exchange; 7; 9  
 Automatic Seasoning Cycle; 8

### C

**Cabinet Probe Alarm;** 16  
**Condenser Probe Alarm;** 16

### D

Date/Time Setting; 11  
 Description of the Appliance; 4  
 Disposal of the Appliance; 23

### E

Electric Power Supply Connection; 19  
**Evaporator Probe Alarm;** 16

### F

FAULTS; 14  
 Features Plate; 5  
 First Switching; 6

### G

General information; 4

### H

**High Evaporator Temperature Alarm;** 17  
**Humidity Probe Alarm;** 16

### I

Inputs and Outputs; 11  
 Inspection; 21  
 Installation; 18

### L

Languages; 12

### M

Manual defrosting; 11  
 Manual Seasoning Cycle; 6

### O

**Open Door signal;** 17

### P

Packaging; 18  
 Prolonged Inactivity; 13

### R

Recipe book; 11  
 Recommendations for Cleaning and Maintenance;  
 13  
 Recommendations for normal use; 13  
 Recommendations for Use; 13  
 REFRIGERANT TECHNICAL CARD; 23  
 Replacement of Parts; 5  
 Rest Cycle; 7; 9  
 Reversibility of the Doors; 22  
 Routine Maintenance; 14  
**RTC Alarm;** 16

### S

SAFETY; 3  
 Service; 12  
 Settings; 11



### U

Unpacking; 18  
 Use of the USB port (Optional); 12

### W

Warranty; 4  
 Water connection; 20

### 3. SAFETY

  It is recommended to carefully read the instructions and warnings contained in this manual before using the appliance. The information contained in the manual is fundamental for the safety of use and for machine maintenance.

 Keep this manual carefully so that it can be consulted when necessary.

 The electric plant has been designed in compliance with the **IEC EN 60335-2-89** Standard.

 Maintain ventilation openings in the appliance casing or in the built-in structure free from all obstructions.

 Do not use mechanical devices or other means to accelerate the defrosting process, other than those recommended by the manufacturer.

 Do not damage the coolant circuit.

 Do not use electrical appliances inside the appliance compartments for storage of frozen food.

 Do not store explosives, such as pressurised containers with flammable propellant, in this unit.

 Do not place anything on the bottom of the device. Use the appropriate racks to store the product.

 The maximum permissible load for the racks is 45kg evenly distributed.

 if the supply cord is damaged, it must be replaced by the manufacturer, its service agent or similarly qualified persons in order to avoid hazard.

 Specific adhesives highlight the presence of mains voltage in the proximity of areas (however protected) with risks of an electrical nature.

 If a stationary appliance is not fitted with a supply cord and a plug, the means for disconnection must be incorporated in the fixed wiring in accordance with the wiring rules.

In the design and construction phase, the manufacturer has paid particular attention to the aspects that can cause risks to safety and health of persons that interact with the appliance.

Carefully read the instructions stated in the manual and those applied directly to the machine, and particularly respect those regarding safety.

Do not tamper with, evade, eliminate or by-pass the installed safety devices. Failure to comply with this requisite can lead to serious risks for personal health and safety.

It is recommended to simulate some test manoeuvres to identify the controls, in particular those relative to switch-on and switch-off and their main functions.

The appliance is only destined for the use for which it has been designed; any other use must be considered improper.

The manufacturer declines all liability for any damage to objects or injury to persons owing to improper or incorrect use.

 All maintenance interventions that require precise technical skill or particular ability must be performed exclusively by qualified staff.

In order to guarantee hygiene and protect the foodstuffs from contamination, the elements that come into direct or indirect contact with the foodstuffs must be cleaned very well along with the surrounding areas. These operations must only be performed using detergents that can be used with foodstuffs, avoiding inflammable products or those that contain substances that are harmful to personal health.

In the case of prolonged inactivity, as well as disconnecting all the supply lines, it is necessary to accurately clean all internal and external parts of the appliance.

## 4. REGULATIONS AND GENERAL INSTRUCTIONS

### 4.1. General information

This manual has been designed by the manufacturer to provide the necessary information to those who are authorised to interact with the appliance.

It is advisable for the receivers of the information to read it carefully and apply it strictly.

Reading the information contained in this document will allow the user to prevent risks to personal health and safety.

Keep this manual for the entire operating life of the appliance in a place which is well-known and easily accessible, so that it is always available when its consultation becomes necessary.

Particular symbols have been used to highlight some parts of the text that are very important or to indicate some important specifications. Their meanings are given below:



**Indicates important information regarding safety. Behave appropriately so as not to risk the health and safety of persons or cause damage.**



**Indicates particularly important technical information that must not be ignored.**

### 4.2. Warranty

The warranty of the appliance and the components we produce has duration of 2 years from the date of delivery and translates into the supply, free of charge, of parts that we consider to be faulty.

These faults must, however, be independent from incorrect use of the product in compliance with the indications stated in the manual.

Fees deriving from labour, journeys and transport are excluded from the warranty.

The materials replaced under warranty are our property and must therefore be returned under the responsibility and expense of the customer.

### 4.3. Description of the Appliance

The refrigerated cabinet, from now on defined as appliance, has been designed and built to preserve foodstuffs in the professional catering ambit.

- 1) **condensation area:** it is positioned in the upper part and is characterised by the presence of the condensing unit.
- 2) **electric area:** it is positioned in the upper/front part and contains the control and power supply appliance as well as electric wiring.
- 3) **cooling/heating area:** one is located in the cell compartment of the cooling unit and another in the heating unit.
- 4) **storage area:** it is situated under the evaporating unit and is destined for preservation of foodstuffs.

The upper part is distinguished by a dashboard that allows accessibility to the electric parts.



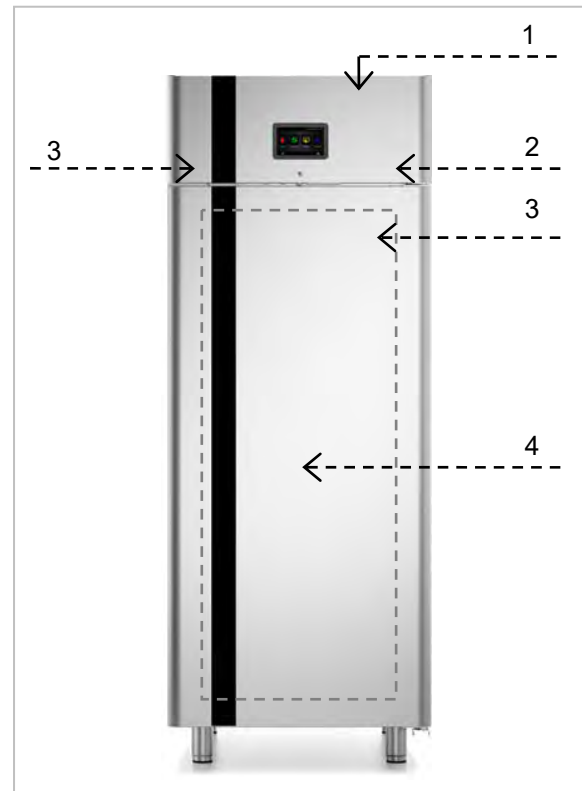

In the front part there is one vertically-opening door, which closes the refrigerated compartment hermetically.



#### 4.4. Features Plate

The identification plate shown is applied directly onto the appliance. It states the references and all indications indispensable for working in safety.

- 1) Appliance code
- 2) Description of the appliance
- 3) Serial number
- 4) Power supply voltage and frequency
- 5) Rated output
- 6) Defrosting output
- 7) Total light output
- 8) Climatic class
- 9) Type and Amount of refrigerant gas
- 10) WEEE symbol

|   |   |    |
|---|---|----|
| CODE /KODE<br>CODICE                              |   | 1  |
| MODEL / MODELL<br>MODELLO                         |   | 2  |
| SERIAL No/SERIEN NR.<br>MATRICOLA                 |   | 3  |
| TENSION/SPANNUNG<br>TENSIONE                      |   | 4  |
| INPUT<br>LEISTUNGS-AUFNAHME<br>POTENZA            |   | 5  |
|   |    | 6  |
|   |    | 7  |
| CLIMATIC CLASS<br>KLIMAKLASSE<br>CLASSE CLIMATICA |   | 8  |
| REFRIGERANT<br>KUEHLMITTEL<br>REFRIGERANTE        |   | 9  |
|   |   | 10 |

The appliances are equipped with climatic class that indicates the room temperature within which the refrigerator is operating correctly. The following climatic classes exist:

| Climatic Class | Room Temperature °C | Related Humidity % |
|----------------|---------------------|--------------------|
| 0              | 20                  | 50                 |
| 1              | 16                  | 80                 |
| 2              | 22                  | 65                 |
| 3              | 25                  | 60                 |
| 4              | 30                  | 55                 |
| 6              | 27                  | 70                 |
| 5              | 40                  | 40                 |
| 7              | 35                  | 75                 |

#### 4.5. Replacement of Parts



Before carrying out any replacement intervention, activate all envisioned safety devices.



In particular, deactivate the electrical power supply using the differential disconnecting switch. When worn components must be replaced, only use original spare parts.



All responsibility is declined for injury to persons or damage to components deriving from the use of non-original spare parts and interventions which could modify the safety requisites, without authorisation of the manufacturer.

## 5. USE AND FUNCTIONING

### 5.1. First Switching

At the first switching of the machine, the device displays the ON / Standby screen.

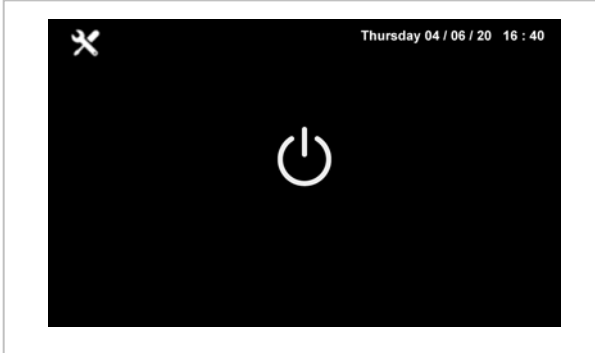

To turn the device on, from the ON/Stand-by screen, press the central area to show the Home screen.

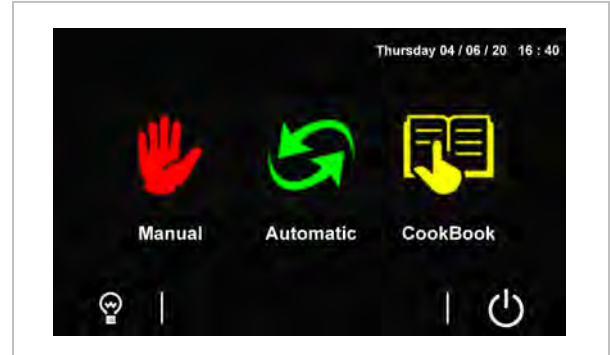

From the Home screen it is possible to enter the functioning mode of the machine simply selecting the desired area.

To switch the device off, press the area  on the Home screen.

### 5.2. Manual Seasoning Cycle

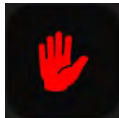

By selecting the area, you will enter the MANUAL menu.

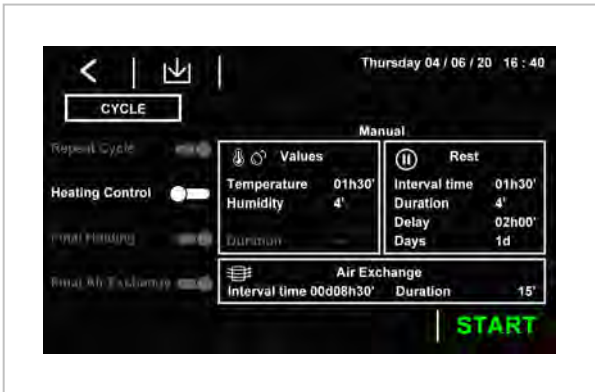





During the setting of a manual cycle, the functions "cell reload", "final holding", "final air exchange" and "duration" are disabled and cannot be enabled.

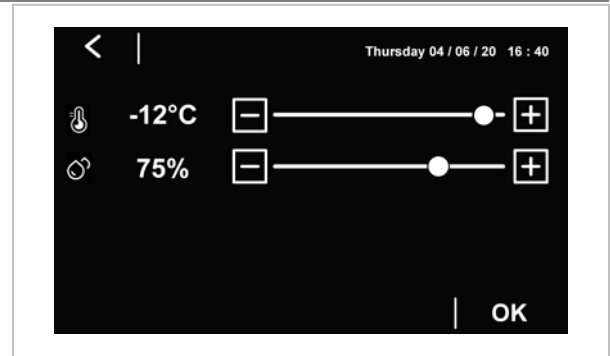

Press the area  to change the temperature and humidity values.



To change the values press the  and  keys or drag the scroll bar icon.

Press  to confirm the set values or press  to abandon the procedure and return to the previous level without saving.

The user can disable the humidity control by setting the humidity to 0%.

The value "OFF" or "humidity control disabled" will be set (This icon  will appear on the display indicating that humidity control is not enabled).



**Rest Cycle**



Press at the area  to change the rest cycle parameters.

During the seasoning process, the product needs periods of absolute rest in which the machine does not regulate neither temperature, nor humidity, nor ventilation inside the chamber.

Following parameters are specific to the rest cycle:

**Time interval.**

It establishes how often a rest period begins. By setting the interval to **MANUAL** (corresponding to 0), the rest cycle can only be started manually.

**Duration.**

Determines how long the rest period lasts. By setting the duration to **OFF** (corresponding to 0), the rest cycle will be disabled.

**Delay.**

It determines how long after the beginning of the phase the first rest interval begins. By setting the delay to 0', the rest period will start immediately at the beginning of the phase.

**Days.**

Determines for how many days, once the initial delay has elapsed, the rest periods should be repeated according to the established interval and duration. The number of days can be set from 1 to 30.

**Air Exchange**

Press at the area



to change the air exchange cycle parameters.

The seasoning process periodically needs an air exchange in the cell in order to always have oxygen-rich air to prevent odours or impurities that could deteriorate the product.

The air exchange fan is operated with a user-defined interval and duration.

Below the specific parameters:

**Time interval.**

It establishes how often an air exchange cycle begins. By setting the interval to **MANUAL** (corresponding to 0), the rest cycle can only be started manually.

**Duration.**

Determines how long the air exchange period lasts.

By setting the duration to **OFF** (corresponding to 0), the rest cycle will be disabled.

Enabling/disabling the "Heating Control"



function, the heating

elements will be enabled/disabled for the entire duration of the cycle if the cell temperature falls below the neutral range established by the setting.

If the heating control is disabled, the icon  on the display will be active for the duration of the cycle.

To start the manual cycle press **START**.

Following screenshot will be displayed:



On the top above the temperature, the SEASONING message will be displayed every 5 seconds (if in progress), and will alternate with the name of the special cycle in progress.







The elapsed time from the start of the cycle will be displayed below the temperature.



The area below the temperature indication is intended to:

- indicate the time remaining for the ending of an ongoing "special cycle". By special cycle we mean: rest cycle, air exchange cycle, smoking cycle, sterilisation/oxygenation cycle.
- indicate the type of cycle in progress (manual / automatic / program name), possibly replaced by the alarm code in progress.

During the execution of a manual cycle the status of the main functions are displayed through icons at the top of the screen.







Find below their meaning when turned on:



|   |                            |
|---|----------------------------|
|  | Compressor on              |
|  | Heating on                 |
|  | Heating control off        |
|  | Evaporator fans on         |
|  | Defrosting in progress     |
|  | Humidification in progress |

|   |                              |
|---|------------------------------|
|  | Dehumidification in progress |
|  | Humidity control off         |
|  | Failure                      |

During the manual cycle, the control keys are displayed at the bottom of the screen.

Please find below their functions:

|   |   |
|---|---|
|    | Turns the light on and off.                             |
|    | Feature not available.                                  |
|    | Manual air exchange cycle activation.                   |
|    | Manual activation of sterilization cycle (optional).    |
|   | Manual Rest Cycle activation                            |
|  | Manual defrost cycle activation                         |
|  | Enter the temperature / humidity set point change page. |

|   |   |
|---|---|
|  | Input/output status and alarms display.             |
|  | If pressed for 3 seconds it stops the manual cycle. |

 The manual cycle has no duration settings; it can only be terminated manually by pressing the **STOP** button.

After a pre-defined downtime, the system switches to "SCREEN SAVER" mode, the display shows the values detected by the probes in use.

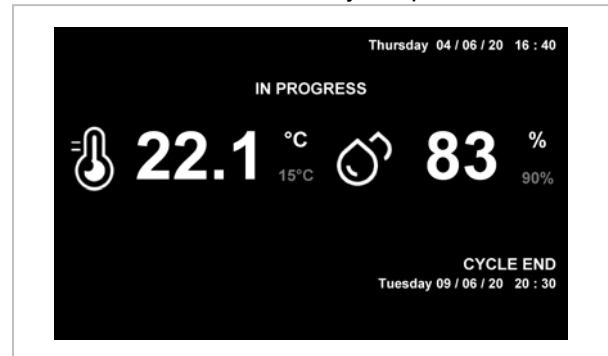

To exit "SCREEN SAVER" mode, just touch the screen. Even an alarm situation in progress interrupts the "SCREEN SAVER" mode.



### 5.3. Automatic Seasoning Cycle

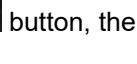

An automatic seasoning cycle can be composed of a maximum number of 30 different phases one

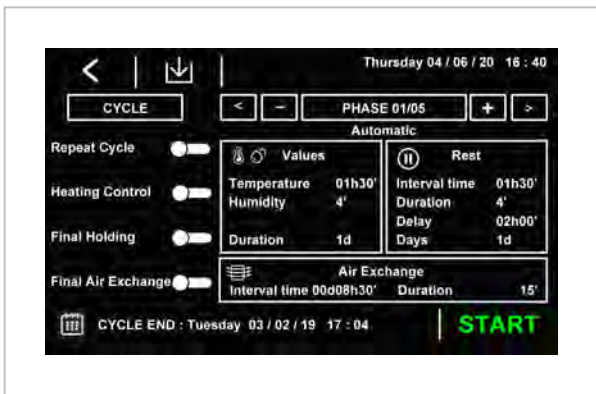



after the other. Selecting the  button, the AUTOMATIC menu is loaded.



To add or remove a processing phase press the  and  keys.

To move from one phase to another, press at the  and  keys.

Enabling the  function at the end of the seasoning cycle, a pop-up will appear on the display that will allow, with a simple touch, to restart the same identical seasoning cycle just completed. However, the controller will always re-propose the settings of the last cycle performed.

Enabling/disabling the  function, the heating elements (and its related utilities) will be enabled/disabled for the entire duration of the cycle if the cell temperature falls below the neutral range established by the setting.

If the heating control is disabled, the icon  on the display will be active for the duration of the cycle.

**Final Holding**

By enabling the function, at the end of the last phase, the machine will maintain unaltered temperature and humidity in the cell until the STOP of the cycle.

**Final Air Exchange**

By enabling the function, at the end of the last phase, the machine will perform a complete air exchange cycle. Any final holding will start after the air exchange.

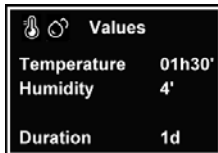

Press the area to change the temperature, humidity, ventilation and duration values.

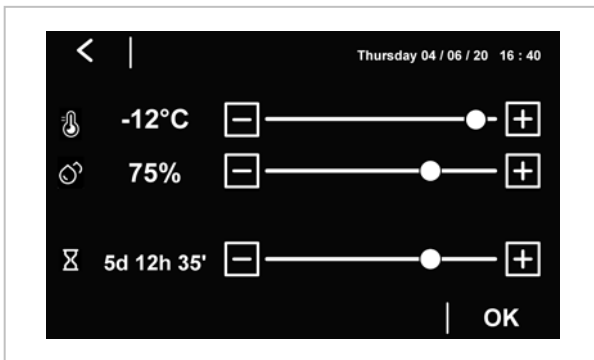

To change the values press the and keys or drag the scroll bar icon.

Press to confirm the set values or press to abandon the procedure and return to the previous level without saving.

**Rest Cycle**

Press at the area to change the rest cycle parameters.

During the seasoning process, the product needs periods of absolute rest in which the machine does not regulate neither temperature, nor humidity, nor ventilation inside the chamber.

Following parameters are specific to the rest cycle:

During the seasoning process, the product needs periods of absolute rest in which the machine does not regulate neither temperature, nor humidity, nor ventilation inside the chamber.

Following parameters are specific to the rest cycle:

**Time interval.**

It establishes how often a rest period begins. By setting the interval to **MANUAL** (corresponding to 0), the rest cycle can only be started manually.

**Duration.**

Determines how long the rest period lasts. By setting the duration to **OFF** (corresponding to 0), the rest cycle will be disabled.

**Delay.**

It determines how long after the beginning of the phase the first rest interval begins. By setting the delay to 0', the rest period will start immediately at the beginning of the phase.

**Days.**

Determines for how many days, once the initial delay has elapsed, the rest periods should be repeated according to the established interval and duration. The number of days can be set from 1 to 30.

**Air Exchange**

Press at the area



to change the air exchange cycle parameters.

The seasoning process periodically needs an air exchange in the cell in order to always have oxygen-rich air to prevent odours or impurities that could deteriorate the product.

The air exchange fan is operated with a user-defined interval and duration.

Below the specific parameters:

**Time interval.**

It establishes how often an air exchange cycle begins.

By setting the interval to **MANUAL** (corresponding to 0), the rest cycle can only be started manually.

**Duration.**

Determines how long the air exchange period lasts.

By setting the duration to **OFF** (corresponding to 0), the rest cycle will be disabled.

The **CYCLE END** icon is displayed at the bottom left: it shows the day and time of the end of the seasoning cycle obtained by summing all the phases set for the cycle in setting. The date and time of the cycle end has no value for the program in setting, it is merely a reference for the user.

To store the set cycle before its execution, press on the icon at the top left: scroll the recipe book pages with the recipe list using the or keys and choose the desired position to save the recipe by assigning a new name or by

overwriting an existing recipe; to complete the procedure, confirm by pressing the **OK** button.



To start the manual cycle press **START**.  
Di seguito la schermata proposta :



During the execution of a manual cycle the status of the main functions are displayed through icons at the top of the screen.

Find below their meaning when turned on:

|  |                              |
|--|------------------------------|
|  | Compressor on                |
|  | Heating on                   |
|  | Heating control off          |
|  | Evaporator fans on           |
|  | Defrosting in progress       |
|  | Humidification in progress   |
|  | Dehumidification in progress |
|  | Humidity control off         |



Failure

During the manual cycle, the control keys are displayed at the bottom of the screen.

Please find below their functions:

|  |   |
|--|---|
|  | Turns the light on and off.                             |
|  | Feature not available.                                  |
|  | Manual air exchange cycle activation.                   |
|  | Manual activation of sterilization cycle (optional).    |
|  | Manual Rest Cycle activation                            |
|  | Manual defrost cycle activation                         |
|  | Enter the temperature / humidity set point change page. |
|  | Input/output status and alarms display.                 |
|  | If pressed for 3 seconds it stops the manual cycle.     |

After a pre-defined downtime, the system switches to "SCREEN SAVER" mode, the display shows the values detected by the probes in use.



To exit "SCREEN SAVER" mode, just touch the screen. Even an alarm situation in progress interrupts the "SCREEN SAVER" mode

## 5.4. Recipe book

From the main menu, selecting the area



, the recipe book is displayed.

From this area you can enter the MY RECIPES section, which lists the automatic seasoning cycles saved with the user's name. It is possible to save up to 10 different recipes.

By pressing on the desired recipe name, you can directly enter the automatic cycle start page (see relevant section).





The selection of a recipe with dashes is not allowed, the pressure on the corresponding area will have no effect.

GB

## 5.5. Settings

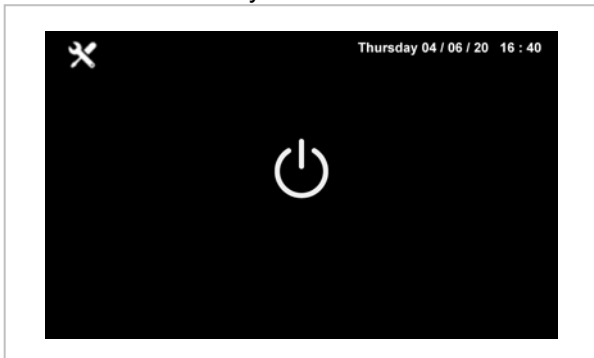

From the ON/Standby screen:

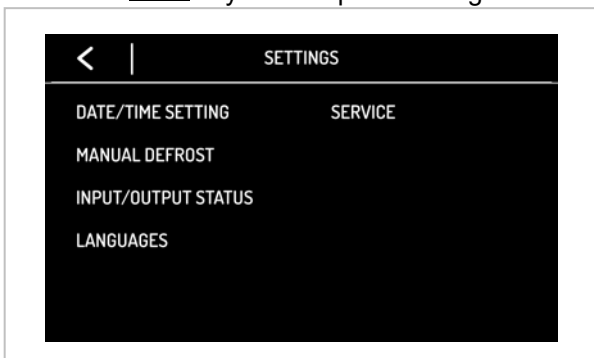

Press the  key to call up the settings menu:



### Date/Time Setting

Within the menu you can set the current date and time. Press  to confirm the set values or press  to abandon the procedure and return to the previous level without saving.

### Manual defrosting

If conditions permit, a manual defrost can be started.

### Inputs and Outputs

Within this menu you can monitor the status of the inputs (temperature probes):

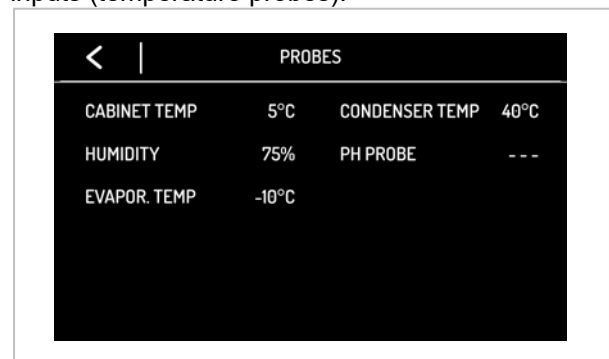

and of the inputs/outputs:

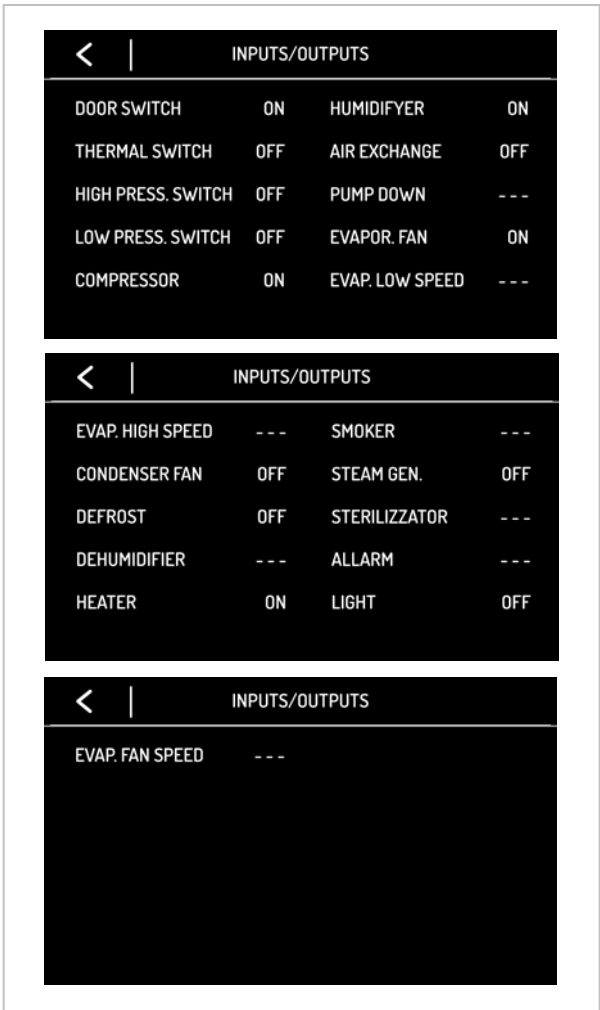

**Languages**

The following languages are available: ITALIANO, ENGLISH, FRANÇAIS, DEUTSCH, ESPAÑOL, PORTUGUÊS. To select the desired language tap near to it.

**Service**

From this section you can enter the following menu

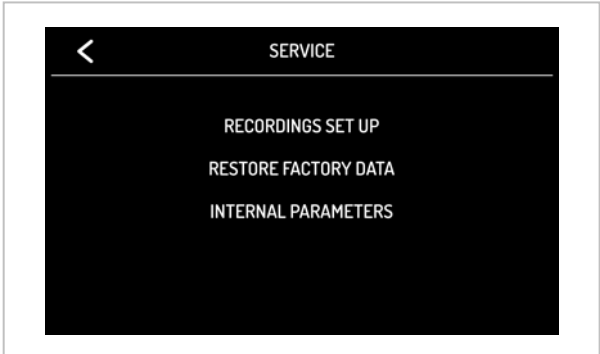

**Recordings Setup**

From this menu it is possible to select the HACCP data to be recorded:

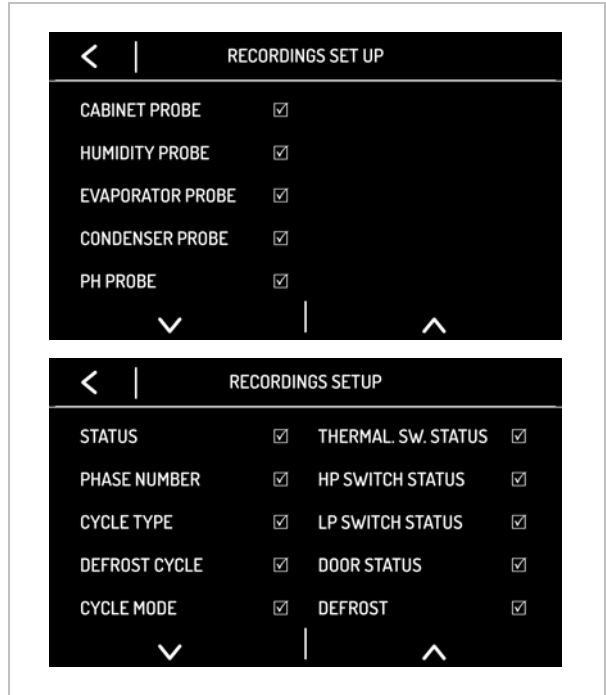

**Restore Factory Data**

Tap on this section to enter the following functions:



The three functions are password protected: **149**.

**Parameters**

Tap on this section to enter the configuration of the parameters.

The function is password protected: **-19**.

**5.6. Use of the USB port (Optional)**

Through the USB port, you can perform the following operations:

- download to USB stick data of the performed cycles (HACCP data)

- download to USB stick the programs saved in the controller
- download to USB stick the parameters saved in the controller
- upload to the controller programs contained on the USB stick
- upload to the controller programs contained on the USB stick

Before inserting the stick into the USB port on the machine, enter the ON/Standby screen:

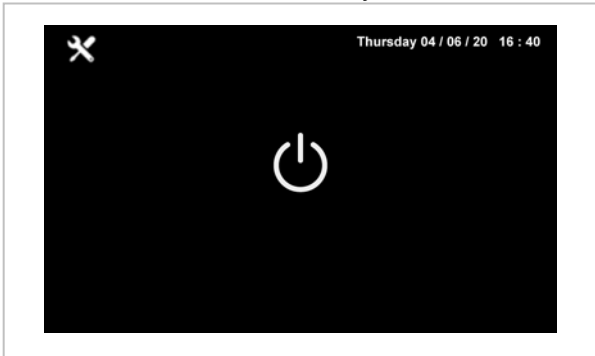

After inserting the USB stick, the following menu will be displayed:

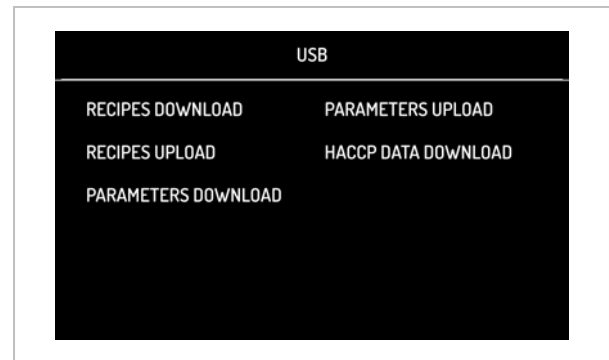

To download the HACCP data, select the start date for HACCP data download:



## 5.7. Recommendations for Use

### Prolonged Inactivity

If the appliance remains inactive for a long period, proceed as follows:

1. Use the automatic disconnecting switch to deactivate connection to the main electrical line.
2. Clean the appliance and surrounding areas thoroughly;
3. Spread a thin layer of cooking oil onto the stainless steel surfaces;
4. Carry out all maintenance operations;
5. Leave the doors ajar to prevent the formation of mould and/or unpleasant odours.

### Recommendations for normal use

In order to ensure correct use of the appliance, it is advisable to apply the following recommendations:

- Do not obstruct the front and rear zones above the condensing unit in order to favour

heat disposal from the condenser to a maximum.

- Always keep the front of the condenser clean using a soft brush and do not use rigid or metal tools that may damage the condenser fins.
- Check the planarity of the appliance rest surface.
- Do not introduce liquid or solid substances at temperatures above the environmental temperature and, however, introduce the material after the appliance has reached the functioning temperature.
- Do not stack the materials to be preserved in contact with the internal walls, so blocking the circulation of air, which guarantees uniformity of the internal temperature of the refrigerated compartment.
- Limit the number of times and the duration of time the doors are open to a maximum.

## 6. CLEANING AND MAINTENANCE

### 6.1. Recommendations for Cleaning and Maintenance



Before carrying out any maintenance intervention, activate all envisioned safety

devices. In particular, deactivate the electrical power supply using the automatic disconnecting switch.

## 6.2. Routine Maintenance

Routine maintenance consists of daily cleaning of all the parts which can come into contact with foodstuffs and the periodic maintenance of the burners, nozzles and draining pipes.

Correct maintenance allows the user to maximise performance levels and operating life and constantly maintain safety requirements.

Do not spray the appliance with direct jets of water or high pressure appliances.

When cleaning stainless steel, do not use iron wool, brushes or scrapers as ferrous particles could be deposited which, on oxidising, could lead to rust.

To remove hardened residues, use wooden or plastic spatulas or abrasive rubber pads.

During long periods of inactivity, spread a protective layer on all stainless steel surfaces by wiping them with a cloth soaked in Vaseline oil and airing the rooms periodically.



Do not use products which contain substances which are harmful and dangerous for personal health (solvents, petrol etc.).

- Check functioning of the electric boards and probes.
- Check the efficiency of the electrical system.

## 6.3. Extraordinary maintenance



**Periodically** have the following operations carried out by specialised staff:



- Periodically clean the condenser using suitable tools (suction device or soft brushes).
- Check the perfect sealing of the door gaskets and replace them if necessary.

- Periodically clean the condensate evaporation tray.
- Check that the electric connections have not loosened.
- Check the efficiency of the heating element





## 7. FAULTS

The information shown below aims to help with the identification and correction of any anomalies and malfunctions which could occur during use. Some of these problems can be resolved by the

user. For the others, precise competency is required and they must therefore only be carried out by qualified staff.

| Problem  | Causes                                   | Solutions  |
|--|--|--|
| The refrigerator unit does not start                                 | End of defrosting                        | It restarts after a pause of three minutes.  |
|  | No Voltage                               | Check plug, sockets, fuses and electric mains  |
|  | Other causes                             |  <b>Contact the after-sales centre.</b> |
| The refrigerator unit functions continuously, cooling insufficiently | Room too hot                             | air the environment  |
|  | Dirty condenser                          | clean the condenser  |
|  | Insufficient door sealing                | check the gaskets  |
|  | Insufficient quantity of refrigerant gas |  <b>Contact the after-sales centre.</b> |







|                                       |                                |  |
|---------------------------------------|--------------------------------|--|
|                                       | Resistances always inserted    |  <b>Contact the after-sales centre.</b> |
|                                       | Condenser fan at a standstill  |  <b>Contact the after-sales centre.</b> |
|                                       | Evaporator fan at a standstill |  <b>Contact the after-sales centre.</b> |
| The refrigerator unit does not stop   | Probe faulty                   |  <b>Contact the after-sales centre.</b> |
|                                       | Thermostat fault               |  <b>Contact the after-sales centre.</b> |
| Presence of ice inside the evaporator | Appliance not level            | use the adjustable feet to level   |
|                                       | Resistances not functioning    | check defrosting activation (only on models with electric defrosting)  |
| Appliance noise                       | Persistent vibrations          | check that there is no contact between the appliance and other objects inside or outside                                   |



| Problem                                  | Causes                                    | Solutions                        |
|--|---|----------------------------------|
| The electronic board remains off.        | Power supply cable incorrectly connected. | Check the electric connection    |
|  | Interrupted fuses                         | Check and replace fuses          |
| The machine does not heat correctly      | Protective Klixon (PTRC) interrupted.     | Check and replace the component. |
| Insufficient humidity in proving chamber | Closed water cock                         | Open water inlet cock            |
|  | Clogged water filter                      | Clean filter                     |
|  | Water inlet electro valve malfunctioning  | Replace component                |

## 7.1. Alarms Display

| Problem | Causes | Effects | Solutions |
|---------|--------|---------|-----------|
|---------|--------|---------|-----------|

|                         |   |   |  |
|-------------------------|---|---|--|
| <b>RTC</b>              | <b>RTC Alarm</b><br>Malfunctioning of the internal clock.<br>Time not set | The buzzer is active. The buzzer can be silenced pressing any key.<br>Any running cycle will be stopped and all outputs disabled..              | Set the date ant the current time.   |
| <b>CABINET PROBE</b>    | <b>Cabinet Probe Alarm</b><br>Cabinet probe damaged                       | The buzzer is active. The buzzer can be silenced pressing any key.<br>Any running cycle will be stopped and all outputs disabled.               | Check the connection and the integrity of the cabinet probe. If necessary replace it.<br> <b>Contact the after-sales service..</b><br>Alla scomparsa dell'errore il ciclo riprende. |
| <b>EVAPORATOR PROBE</b> | <b>Evaporator Probe Alarm</b><br>Evaporator probe damaged                 | The buzzer is active. The buzzer can be silenced pressing any key.<br>The defrostings end time-out (see parameter d3)                           | Check the connection and the integrity of the evaporator probe. If necessary replace it.<br> <b>Contact the after-sales service..</b>   |
| <b>CONDENSER PROBE</b>  | <b>Condenser Probe Alarm</b><br>Condenser probe damaged                   | The buzzer is active. The buzzer can be silenced pressing any key.<br>The condenser fan will runs in parallel to the compressor.                | Check the connection and the integrity of the cell probe. If necessary replace it.<br> <b>Contact the after-sales service..</b>   |
| <b>HUMIDITY PROBE</b>   | <b>Humidity Probe Alarm</b><br>Humidity probe damaged.                    | The buzzer is active. The buzzer can be silenced pressing any key.<br>Any cycle that involves the use of the humidity probe will be terminated. | Check the connection and the integrity of the humidity probe. If necessary replace it.<br> <b>Contact the after-sales service..</b>   |
| <b>POWER FAILURE</b>    | <b>Power failure alarm</b>  |   | Verify the electrical power supply.  |

| Problem                            | Causes   | Effects  | Solutions  |
|------------------------------------|--|--|--|
| <b>EVAPORATOR HIGH TEMPERATURE</b> | <p><b>High Evaporator Temperature Alarm</b></p> <p>Evaporator fan out of order.<br/>Heating elements always inserted..</p> | <p>The buzzer is active. The buzzer can be silenced pressing any key.</p> <p>The temperature detected by the probe is higher than the set value (60°C)</p> | <p>Replace the evaporator fan<br/>Verify the heating element connection</p> <p> <b>Contact the after-sales service.</b></p> |
| <b>OPEN DOOR</b>                   | <p><b>Open Door signal</b></p> <p>Door opening</p>   | <p>The buzzer is active. The buzzer can be silenced pressing any key.</p>  | <p>The signal automatically returns once the door is closed.</p>   |

| Problem                            | Causes   | Solutions   |
|------------------------------------|--|---|
| <b>NO COMMUNICATION</b>            | <p><b>Interface communication error user- control module.</b></p>  | <p> <b>Contact the after-sales service.</b></p>  |
| <b>POWER BOARD INCOMPATIBILITY</b> | <p><b>Interface compatibility error user- control module.</b></p>  | <p> <b>Contact the after-sales service.</b></p>  |
| <b>CONDENSER OVERHEAT</b>          | <p>The temperature of the condenser has exceeded the first limit imposed.</p> <ul style="list-style-type: none"> <li>• The condenser fan will be turned on</li> <li>• The alarm output will be activated.</li> </ul>   | <p> <b>Contact the after-sales service.</b></p> <ul style="list-style-type: none"> <li>➤ Air the room.</li> <li>➤ Clean the condenser.</li> <li>➤ Check that the fans are working properly.</li> </ul> |
| <b>COMPRESSOR SHUTDOWN</b>         | <p>The temperature of the condenser has exceeded the second limit imposed.</p> <ul style="list-style-type: none"> <li>• It will not be allowed either select or start any operating cycle.</li> <li>• If the error occurs during an operating cycle, the cycle will be interrupted</li> <li>• The alarm output will be activated.</li> </ul> |   |

## 8. INSTALLATION

### 8.1. Packaging And Unpacking

Move and install the appliance respecting the information provided by the manufacturer, shown directly on the packaging, on the appliance and in this manual.

The lifting and transportation system of the packaged product envisages the use of a fork-lift truck or a pallet stacker, using which particular attention must be paid to balancing the weight in order to prevent the risk of overturning (avoid excessive tilting!).



**ATTENTION:** When inserting the lifting device, pay attention to the gas supply pipe and the position of the feet.



**ATTENTION:** given the presence of weights concentrated in the high part of the appliance, do not drag the appliance during movements (tipping hazard and damage to feet).

The packaging is made of cardboard and the pallet of wood. A series of symbols is printed on the cardboard packaging which highlights, in accordance with international standards, the provisions which the appliances must be subject to during loading, unloading, transportation and storage.



On delivery, check that the packaging is intact and has not suffered any damage during transportation.

Any damage must be notified to the transportation company immediately.

The appliance must be unpacked as soon as possible to check that it is intact and undamaged. Do not cut the cardboard with sharp tools in order to prevent damage to the steel panels underneath.

Pull the cardboard packaging upwards.

After having unpacked the appliance, check that the features correspond to those requested in the order;

For any anomalies, connect the dealer immediately.



Packaging elements (nylon bags, polystyrene foam, staples ...) must not be left within reach of children.

Remove the protective PVC film from the internal and external walls, avoiding the use of metal tools.



Inside the cooling compartment, guides for the tray are located at the bottom.

### 8.2. Installation

All the installation phases must be considered, from the moment of creation of the general plan.

The installation area must be equipped with all power supply and production residue drainage connections and must be suitably lit and respect current laws regarding hygiene and sanitary requirements.

To optimise consumption and reduce wear of the machine, do not position it in the vicinity of heat sources or in environments where temperatures are too high.

Proceed with appliance levelling, acting on the the individual feet.



This appliance can only be installed and operate in rooms which are permanently ventilated, in order to guarantee correct operation.



Connect and leave for a certain period of time (at least 2 hours) before checking functioning. During transport it is probable that the compressor lubricant oil has entered the

refrigerant circuit blocking the capillary: as a consequence the appliance will function for a

certain period of time without producing cold until the oil has returned to the compressor.



**ATTENTION:** the appliance requires the minimum functioning spaces as shown in the diagram.

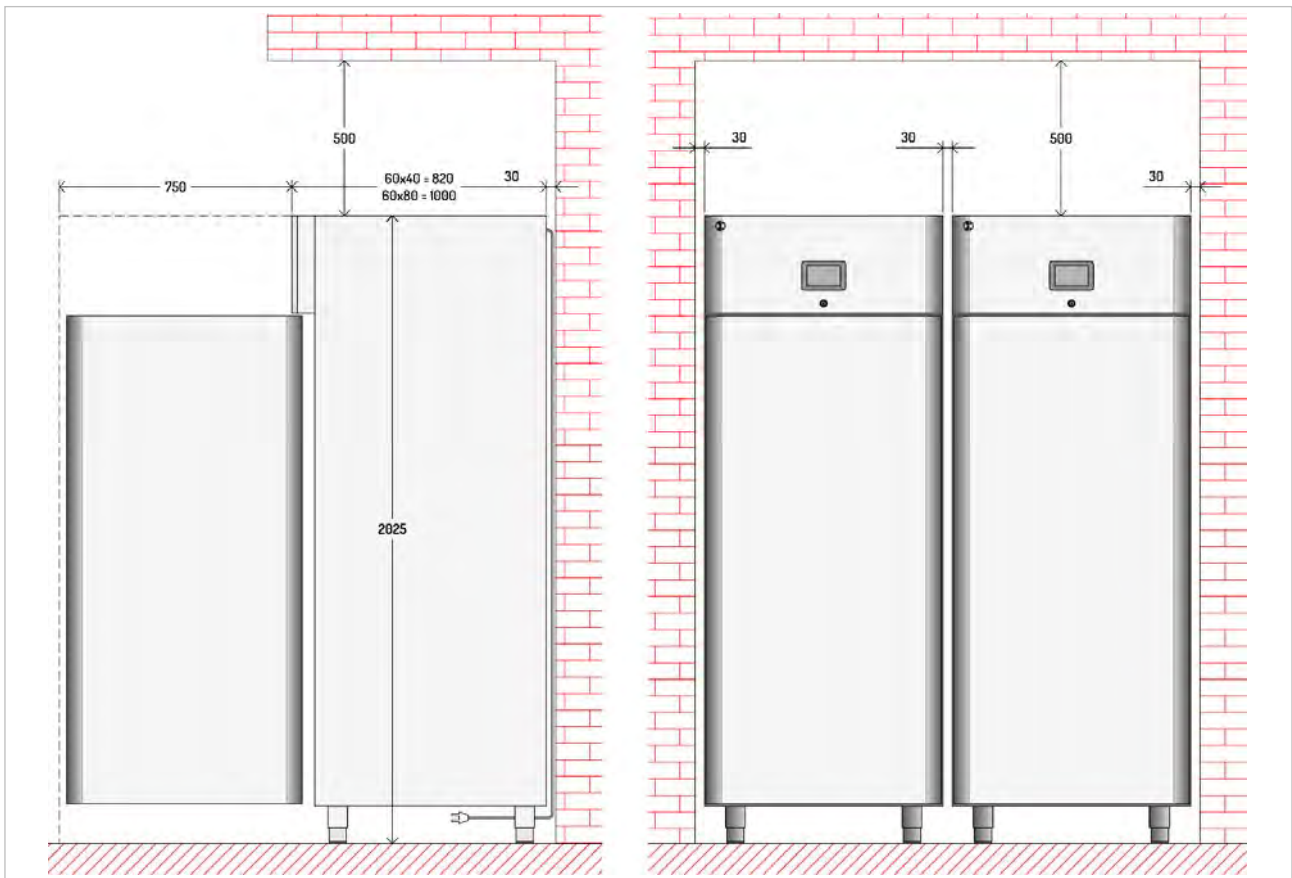

GB

### 8.3. Electric Power Supply Connection

Connection must be carried out by authorised and qualified staff, respecting the current laws regarding the subject and using appropriate prescribed material.



Before connecting the appliance to the electric mains check that the voltage and the frequency correspond to the data stated on the registration plate applied on the rear of the appliance.



The equipment is supplied with one of the following operating voltages:

- 230V 1~ 50Hz
- 220V1~ 60Hz.



Before connection, ensure the presence of a relevant differential switch with adequate power in the mains power supply, upstream from the appliance, in order to protect the appliance from overloads or short circuits

## 8.4. Water connection



The appliance must be supplied with drinking water.

The ultrasonic humidifier works with demineralised water. If you were to use normal water this will decrease the life of the transducers, in particular the maintenance interval for cleaning or replacement of the transducers.

Below the minimum requirements to be met :

| Description | Value                                  |
|-------------|--|
| Pressure    | 100÷600 kPA - 1÷6 bar                  |
| Temperature | 1÷40 °C                                |
| pH          | 6.5÷8                                  |
| Hardness    | 0÷3°F - (0÷30 mg/l CaCO <sub>3</sub> ) |
| Dry Residue | <1500 mg/L                             |
| Iron        | < 0,1 mg/l                             |
| Manganese   | <0,05 mg/l                             |
| Chlorides   | <0,1 mg/l                              |
| Sulphates   | <0,25 mg/l                             |

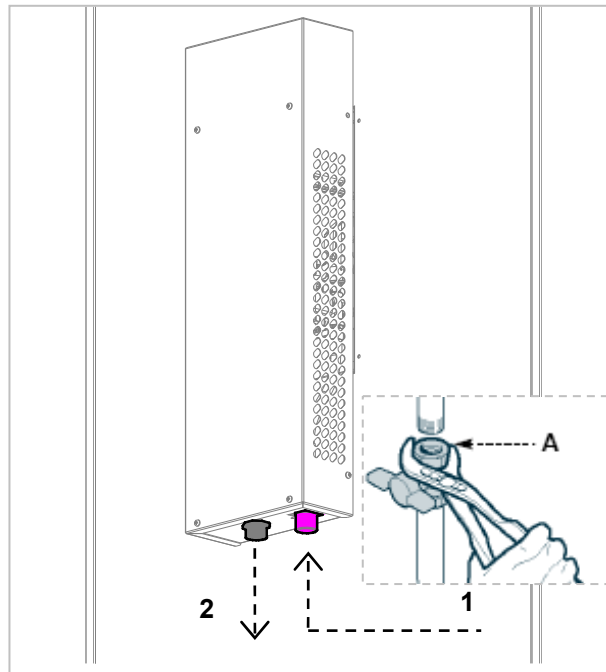

To carry out connection, connect the mains pipe to the appliance connection pipe ( $\varnothing \frac{3}{4}$ " (1), interposing a shut-off cock (A) to interrupt the water supply when necessary. Downstream from this, install some easily reachable filters.

The water temperature must be between 5°C and 50°C.

The water pressure must be enough to guarantee a correct functioning (see the following table).

Connect the safety discharge (2). Arrange a funnel to grant the continuity interruption of the draining pipe (3). Connect a drain trap to prevent the return of odours (4).

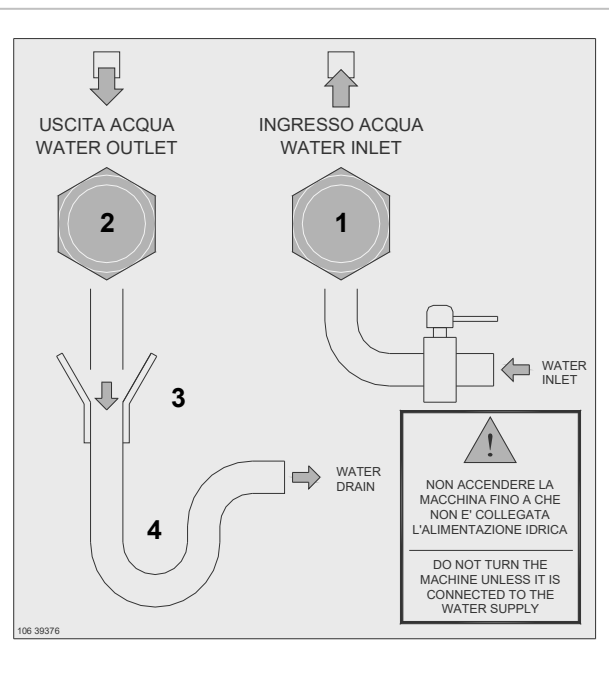

Once the installation is completed, flush out the supply line for few minutes by piping water directly into the drain without sending it into the humidifier. This will eliminate any dross or processing residues that may block the inlet valve.



Do not add disinfectants or corrosion inhibitors in the water, as these are potential irritants; it is absolutely forbidden to use well or industrial water, or water from cooling circuits and, in general, of potentially contaminated water (chemically or bacteriological).



The drainage water is not toxic and can be

discharged into the sewerage system.

## 8.5. Inspection

The appliance is delivered in conditions that it can be started-up by the user.

This functionality is guaranteed by passing the tests (electric inspection - functional inspection,

appearance inspection) and relative certification through the specific attachments.

## 9. TECHNICAL NOTES

### 9.1. Accessory wheels assembly kit

- Unscrew the feet (1) until they are removed completely
- Fix the wheel (2) and base (3) board to the bottom of the cabinet using the screws supplied.

- The screws of each wheel can be inserted in the envisioned 4 Ø 6mm holes.

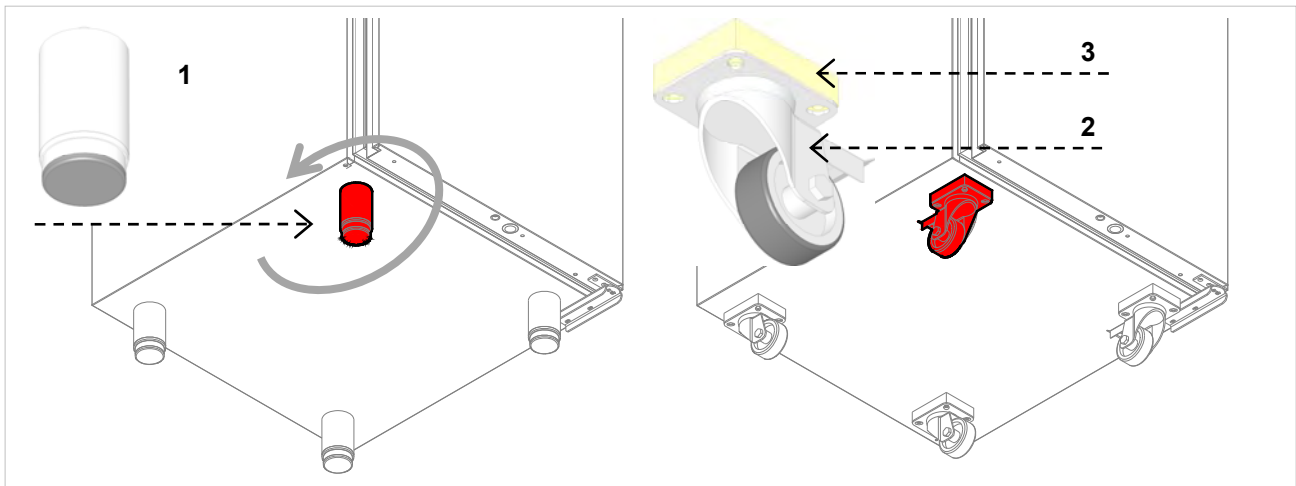

## 9.2. Reversibility of the Doors

GB

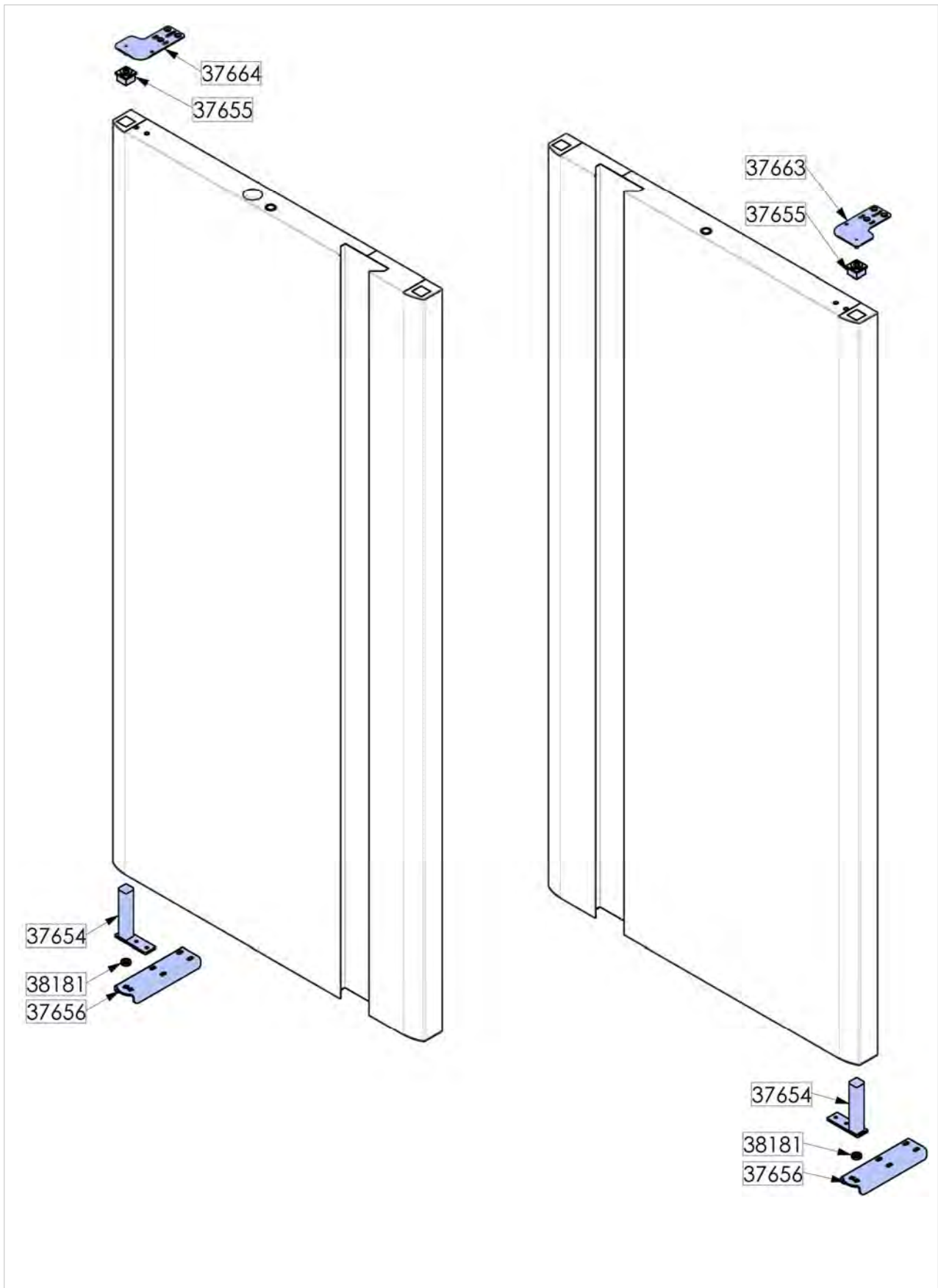



## 10. DISPOSAL OF THE APPLIANCE

 This appliance is marked in compliance with the 2002/96/EC European Directive, WASTE ELECTRICAL AND ELECTRONIC EQUIPMENT (WEEE).

 By assuring that this product is disposed of correctly, the user contributes to preventing the potential negative consequences on the environment and health.



The  symbol found on the product or on the accompanying documentation indicates that this product must not be treated as domestic

waste but must be taken to suitable collection points for the recycling of electric and electronic appliances.

Dispose of it following local regulations regarding waste disposal.

For further information regarding the treatment, recovery and recycling of this product, contact the relevant local office, the domestic waste collection service or the shop where the product was purchased.

GB

## 11. REFRIGERANT TECHNICAL CARD

The refrigerant used in the machine is **R134a**.

### IDENTIFICATION OF DANGERS

The rapid evaporation of the liquid can cause freezing. The inhalation of high concentrations of vapour can cause irregular heartbeat, short term narcotic effects (including vertigo, headache and mental confusion), fainting and death.

- Effects to the eyes: Freezing or cold burns caused by contact with the liquid.
- Effects on the skin: Freezing or cold burns caused by contact with the liquid.
- Effects of ingestion. Ingestion is not considered a means of exposure

### FIRST AID

**Eyes:** In the case of contact, wash the eye well using a large amount of water for at least 15 minutes. Consult a doctor.

**Effects on the skin:** Wash with water for at least 15 minutes after excessive contact. If necessary, cure freezing by gently warming the area in question. Consult a doctor in the case of irritation.

**Ingestion:** Ingestion is not considered a means of exposure.

**Inhalation:** If large concentrations are inhaled, go into the open air. Keep the person calm. If the person cannot breathe, perform artificial respiration. If respiration is difficult, apply oxygen. Consult a doctor.

